

---

**Expert**

**A**



---

**Boss**

**A**



---

**Thief**

**A**



---

**Investigator**

**A**



---

**Student**

**A**



---

**Surprise**

**A**



---

**Discovery**

**A**



---

**Challenge**

**A**



---

**Punishment**

**A**



# Mistake

A

🧪 | 10

# Trick

A

🧪 | 11

# Test

A

🧪 | 12

# Meeting

A

🧪 | 13

# Hobby

A

🧪 | 14

# Mix-Up

A

🧪 | 15

## Saying "I love you"

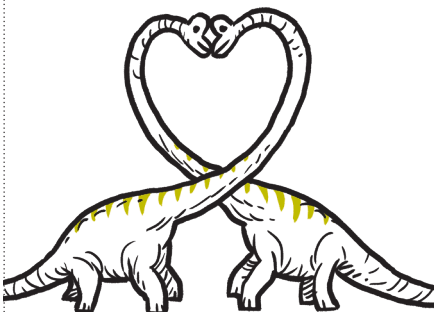

⚡

🧪 | 1

## Taking out the rubbish



⚡

🧪 | 2

## Hunting a T-Rex

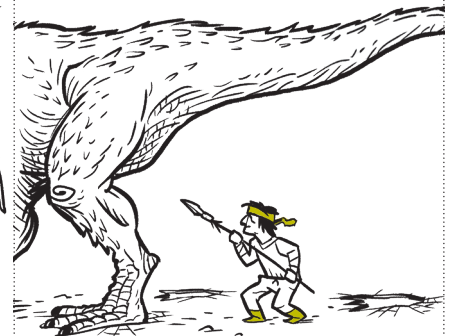

⚡

🧪 | 3

## Mowing the lawns

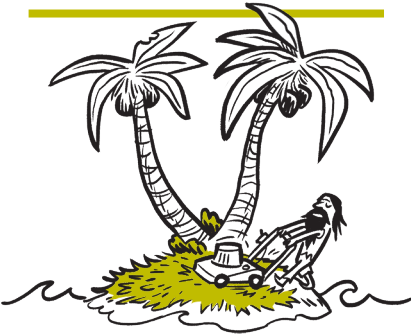

## Fleeing a zombie outbreak

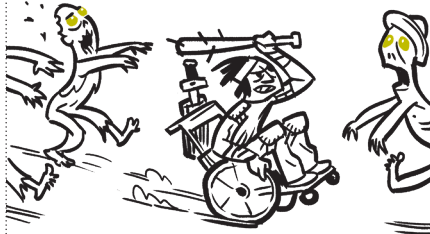

## Jumping a motorcycle

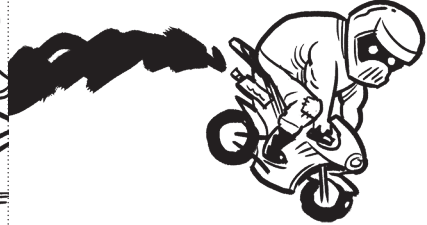

## Reading minds

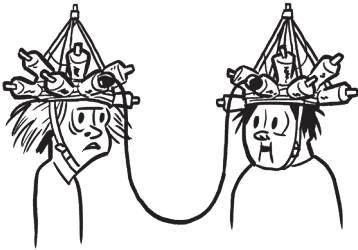

## Crashing the computer

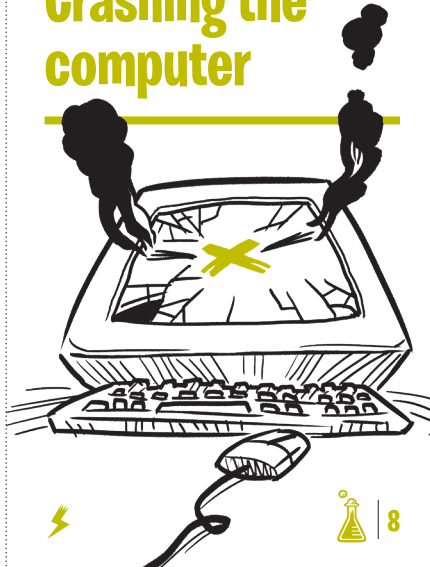

## Racing cats



## Breakdancing



## Eating your Grandma's cooking



## A Pā

An ancient fortified village



## The International Space Station

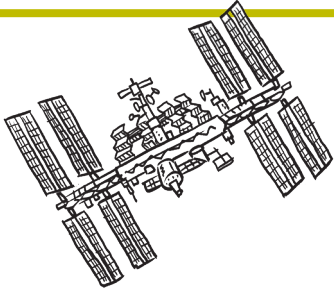

13

## The supermarket



14

## The Pyramids



15

## World War II



16

## An underwater city



17

## A stone circle



18

## Opposite World



19

## An insane asylum



20

## The cricket ground



21

## A dark alley



## Polyfest

The largest Māori and Pacific Island cultural festival in the world



## A bonfire on the beach

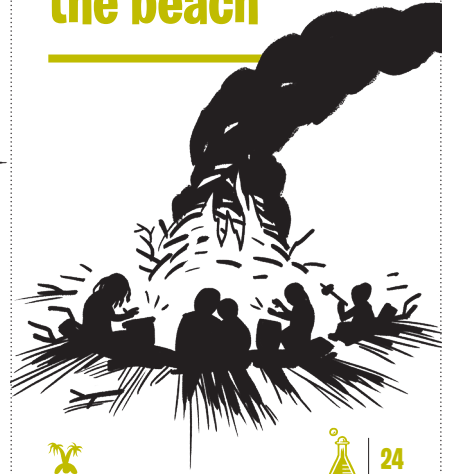

## A living tattoo



## A bowl of writhing huhu grubs



## A deadly mere



## Chocolate milk



## A jar full of bogeys



## Snot lipstick





## Night-vision goggles

---

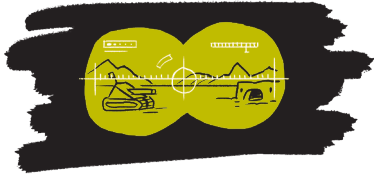

 | 31

## A spicy taco

---



 | 32

## Gravity

---



 | 33

## A gravestone

---



 | 34

## A cobra in a box

---

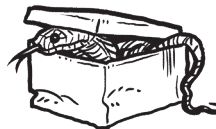

 | 35

## Lost aliens

---

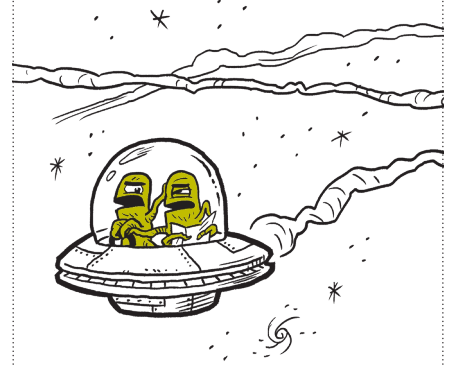

 | 36

## Chainsaws

---

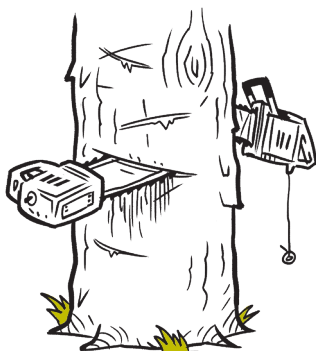

 | 37

## The light of a billion suns

---

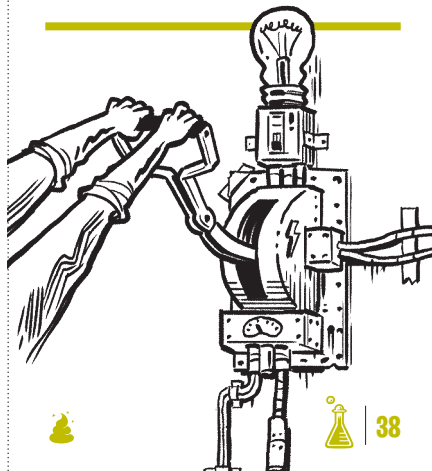

 | 38

## A lock of grandma's hair

---



 | 39

## A wise kunekune

A small hairy domestic pig



## The dental nurse

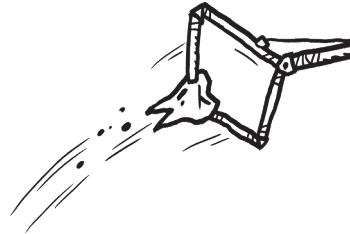

## My footy coach



## Zeus

The Ancient Greek god of lightning



## An astronaut

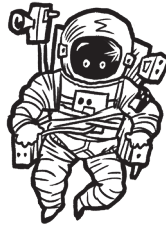

## An evil scientist



## Australians



## Identical twins

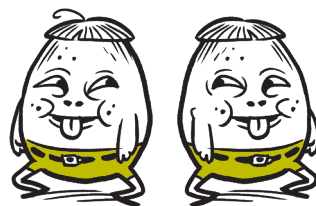

## Kupe

The great Polynesian navigator who discovered New Zealand



## A creeper

---



 49

## Controlling plants

---

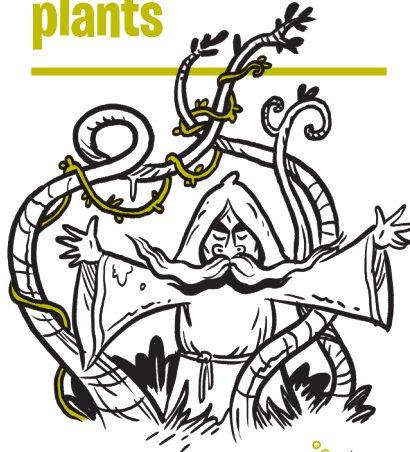

 50





# MORE AWESOME

Blank card templates, alternate rules,  
and much more can be found at  
[awesome.tki.org.nz](http://awesome.tki.org.nz)

# CREDITS

*Game of Awesome* was produced for the  
**Ministry of Education** by **Chrometoaster**:

- **Design and writing team** –  
Robert Whitaker, Aaron McKirdy, Morgan Davie, Nic Gorman, Dave Turnbull
- **Illustration** – Gavin Mouldey
- **Education consultancy** –  
Michael Absolum and Ian Stevens (*Evaluation Associates*)  
Rachel Bolstad and Sarah Beresford (*NZCER*)

The ideas on the cards were developed with groups of boys from Te Aro School (Wellington) and St. Patrick's College (Wellington). Special thanks to the teachers of Newtown, Houghton Valley, Korokoro and Kilbirnie Schools who helped with the design of the game.

# COPYRIGHT & CREATIVE COMMONS



Text and illustration copyright © Crown 2016 released under a  
**Creative Commons BY-NC-SA 2.0 license**.

This means you can share (copy and redistribute the material in any medium or format) and adapt (remix, transform, and build upon the material) as you'd like under the following conditions:

- **Attribute:** You give appropriate credit for the source material.
- **Non-commercial:** You may not use the material for commercial purposes.
- **Share-alike:** If you remix, transform, or build upon the material, you must distribute your contributions under the same license.

